

### ABSOLUTE MAXIMUM RATINGS

Item	Symbol	Min.	Max.	Unit
Supply Voltage(Logic)	$V_{DD} - V_{SS}$	-0.3	6.0	V
Supply Voltage(LCD)	$V_{OUT} - V_{SS}$	-0.3	14.5	V
Input Voltage	$V_I$	-0.3	$V_{DD} + 0.3$	V
Operating Temp.	$T_{opr}$	-20	70	°C
Storage Temp.	$T_{stg}$	-30	80	°C

### MECHANICAL DATA

Item	Nominal Dimensions	Unit
Module Size ( W x H x T )	45.0 x 50.0 x 10.0	mm
Viewing Area ( W x H )	39.0 x 28.0	mm
Dot Pitch ( W x H )	0.282 x 0.36	mm
Dot Size ( W x H )	0.252 x 0.33	mm
Weight	Approx. 20	g

### ELECTRICAL CHARACTERISTICS ( $V_{DD}=3.3V$ to $5.0V$ )

Item	Symbol	Test Condition	Min.	Typ.	Max.	Unit
Input High Voltage	$V_{IH}$	--	2.0	--	$V_{DD}$	V
Input Low Voltage	$V_{IL}$	--	0	--	0.8	V
Output High Voltage	$V_{OH}$	$I_{OH} = -0.1mA$	$V_{DD}-0.2$	--	$V_{DD}$	V
Output Low Voltage	$V_{OL}$	$I_{OL} = 0.1mA$	0	--	0.2	V
Supply Current	$I_{DD}$	$V_{DD} = 5.0V$	--	0.4	0.8	mA
LCD Driving Voltage	$V_0 - V_{SS}$	$T_a=25^\circ C$	--	9.9	--	V

### PIN CONNECTIONS (CN1/CN2)

Pin	Symbol	Level	Function
1	$V_{SS}$	0V	GND
2	$V_{DD}$	3.3V-5V	Power supply for logic
3	$/CS1$	L	Chip selection signal. Active "L".
4	A0	H/L	A0="H": Display data A0="L": Instruction code
5	SCL	H/L	Serial colck input
6	SI	H/L	Serial data input
7	$/RES$	L	Reset signal. Active "L".
8	LEDA	5V	Power supply for LED backlight LEDK is connected to $V_{SS}$ on PCB
9	NC	--	No connection
10	NC	--	No connection
11	NC	--	No connection
12	NC	--	No connection

### BLOCK DIAGRAM

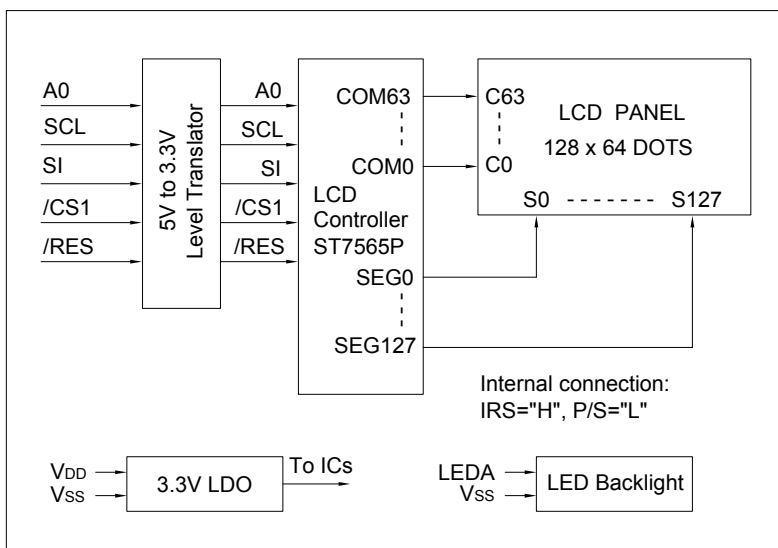

### LED BACKLIGHT SPECIFICATIONS ( $T_a=25^\circ C$ )

Item	Symbol	Typ.	Max.	Unit
Forward Voltage	$V_f$	2.9	3.1	V
Forward Current	$I_f$	20	--	mA
LED Color		White		